

# Flex Single Sided Design features

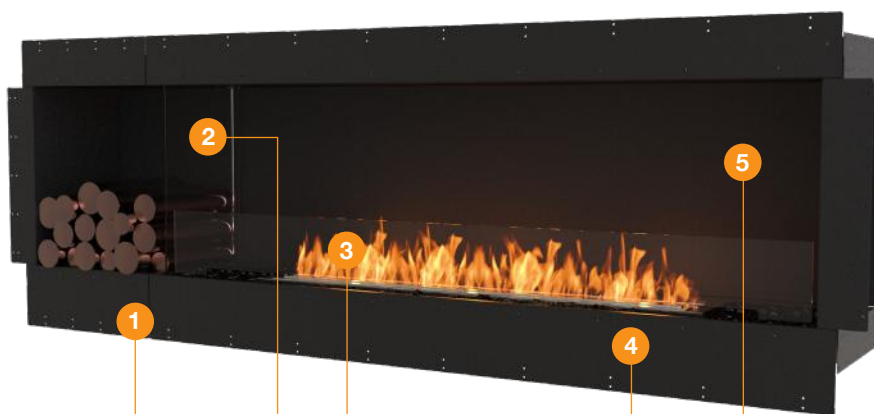

## 1. Zero Clearance

Self-contained, zero clearance construction allows your Flex fireplace to be framed into wood or metal studs, providing installation freedom and flexibility for builders, architects, interior designers, landscapers and homeowners.

## 2. Decorative Side Box

Customise your fireplace design with a decorative box placed on one or more sides, and fill with your chosen non-combustible accessory.

## Built to Last a Lifetime

Zinc sealed steel construction powder coated with super hi-temp black paint prevents rusting so all fireplaces can be used both indoors or outdoors.

## Quick and Easy Installation

Requiring virtually no assembly, Flex Fireplaces are designed to be placed into the desired location, safely secured into position, and operated immediately.

## 3. Glass Fire Screen/s

The toughened glass fire screen stabilises the flame in windy conditions. The Integrated windscreen sits flush behind the frame.

## No Connections

Light up outdoor spaces with a soft, alluring glow - easily and efficiently, without cumbersome connections.

## 4. Colours

Available in a timeless black finish, Flex Fireplaces come with Stainless Steel or Black burners.

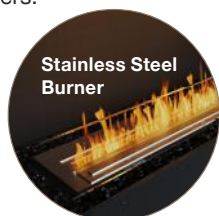

## 5. Single Room Application

Single Sided fireplaces feature one open side - view the flame from the front.

## No Flue, No Chimney, No Vent

Fueled by clean-burning e-NRG bioethanol, our burners produce a beautiful orange flame without any smoke, soot or ash.

## Forefront of fireplace technology

Backed by 17 years of research and development, and third-party certification, each model in the Flex series features world-class safety and fuel ignition technologies.

## Global Compliance

These models comply with existing standards in the USA, Europe, UK and Australia. O-TL listed to UL1370, EN 16647 BSI Certified and ACCC Safety Mandate compliant.

*\*Decorative media is not to be placed directly on top of the burner or anywhere they can interfere with the operation of the burner or the stability of flame.*

## Included Accessories



Jerry Can with Safety Spout & e-NRG bottle adaptor



Lighting Rod & Lighter



XL Baffles  
(XL Burners Only)



Black Glass Charcoal\*



Glass Fire Screen/s

## Optional Accessories



Decorative Steel Logs\*



Disclaimer: All product specifications and data are subject to change without notice and believed to be correct at the time of publication. MAD Design Group (MDG), its affiliates, agents, and employees, and all persons acting on its or their behalf (collectively, "MAD Design Group"), disclaim any and all liability for any errors, inaccuracies or incompleteness contained herein or in any other disclosure relating to any product. MDG disclaims any and all liability arising out of the use or application of any product described herein or of any information provided herein to the maximum extent permitted by law. The product specifications do not expand or otherwise modify MDG's terms and conditions of purchase, including but not limited to the warranty expressed therein, which apply to these products. No license, express or implied, by estoppel or otherwise, to any intellectual property rights is granted by this document or by any conduct of MDG. Customers using or selling MDG products not expressly indicated for use in such applications do so entirely at their own risk and agree to fully indemnify MDG for any damages arising or resulting from such use or sale. Please contact authorised personnel from MDG to obtain written terms and conditions regarding products designed for such applications. Images are indicative only.

# Flex 50SS Specifications

## Burner Ventilation and Efficiency\*

## Construction

Flex Model	Compatible Burner	Fuel Capacity	Heats on Average (Indoors)	Approx. Burn Time	Minimum Room Size	Viewing Area Size	Minimum Wall Length
50SS	XL900	9 L [2.4 Gals]	Over 60 m <sup>2</sup> [645 ft <sup>2</sup> ]	8 - 13 hours	110 m <sup>3</sup> [3,884 ft <sup>3</sup> ]	1,270mm [50in]	1,475mm [58in]
50SS.BXL 50SS.BXR	XL500	5 L [1.3 Gals]	Over 40 m <sup>2</sup> [430.6 ft <sup>2</sup> ]	10 - 13 hours	80 m <sup>3</sup> [2,825 ft <sup>3</sup> ]		

Awards	2020 BIMsmith Best Award (USA) 2018 Attendees Choice Award (USA)
Application	Indoor & Outdoor
Surround Colour	 Black
Burner Colours Options	 Stainless Steel  Black
Materials	Mild Steel (Zinc Sealed) Hi-temp Powder-coat, Toughened Glass, Grade 304 Stainless Steel Burner, with optional Black Ceramic Coating
Approx. Weight	<b>50SS</b> 71.4kg [157.1lbs] <b>50SS.BXL + 50SS.BXR</b> 69.9kg [153.8lbs] Weight includes burner/s, black glass charcoal, fire screen.
Fuel Type	e-NRG Bioethanol / <a href="http://e-NRG.com">e-NRG.com</a>



\*These values are indicative only and may vary depending on the model purchased, installation, and the seasonal resource used to manufacture e-NRG. Physical model dimensions should be verified against cut out dimensions BEFORE installation begins to confirm tolerances align. These models comply with existing standards in the USA, Europe, UK and Australia. O-TL listed to UL1370, EN 16647 BSI Certified and ACCC Safety Mandate compliant.

FOR MORE INFORMATION PLEASE REFERENCE THE CLEARANCE & INSTALLATION MANUAL

Disclaimer: All product specifications and data are subject to change without notice and believed to be correct at the time of publication. MAD Design Group (MDG), its affiliates, agents, and employees, and all persons acting on its or their behalf (collectively, "MAD Design Group"), disclaim any and all liability for any errors, inaccuracies or incompleteness contained herein or in any other disclosure relating to any product. MDG disclaims any and all liability arising out of the use or application of any product described herein or of any information provided herein to the maximum extent permitted by law. The product specifications do not expand or otherwise modify MDG's terms and conditions of purchase, including but not limited to the warranty expressed therein, which apply to these products. No license, express or implied, by estoppel or otherwise, to any intellectual property rights is granted by this document or by any conduct of MDG. Customers using or selling MDG products not expressly indicated for use in such applications do so entirely at their own risk and agree to fully indemnify MDG for any damages arising or resulting from such use or sale. Please contact authorised personnel from MDG to obtain written terms and conditions regarding products designed for such applications. Images are indicative only.

# Flex 50SS

Physical model dimensions should be verified against cut out dimensions BEFORE installation begins to confirm tolerances align.

## ESF.FX.50SS (Flame only)

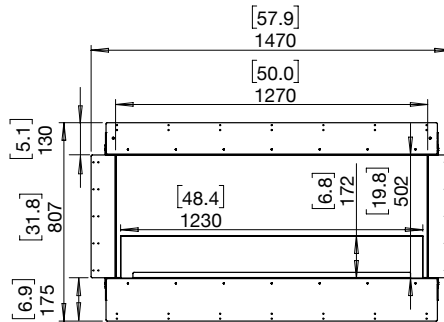

## ESF.FX.50SS.BXL (Left Decorative Box)

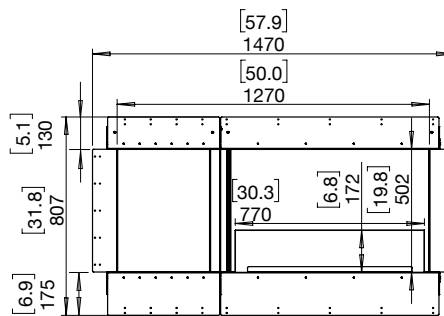

## ESF.FX.50SS.BXR (Right Decorative Box)

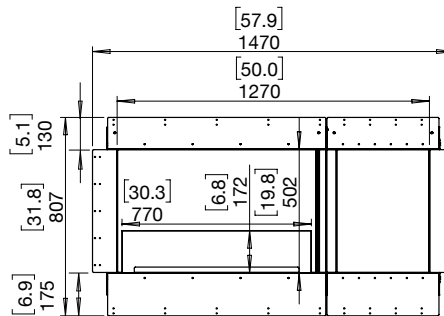

## Side View

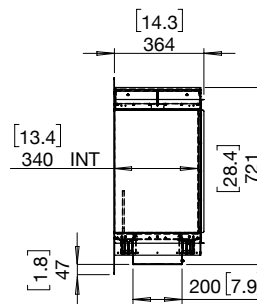

FOR MORE INFORMATION PLEASE REFERENCE THE CLEARANCE & INSTALLATION MANUAL

Disclaimer: All product specifications and data are subject to change without notice and believed to be correct at the time of publication. MAD Design Group (MDG), its affiliates, agents, and employees, and all persons acting on its or their behalf (collectively, "MAD Design Group"), disclaim any and all liability for any errors, inaccuracies or incompleteness contained herein or in any other disclosure relating to any product. MDG disclaims any and all liability arising out of the use or application of any product described herein or of any information provided herein to the maximum extent permitted by law. The product specifications do not expand or otherwise modify MDG's terms and conditions of purchase, including but not limited to the warranty expressed therein, which apply to these products. No license, express or implied, by estoppel or otherwise, to any intellectual property rights is granted by this document or by any conduct of MDG. Customers using or selling MDG products not expressly indicated for use in such applications do so entirely at their own risk and agree to fully indemnify MDG for any damages arising or resulting from such use or sale. Please contact authorized personnel from MDG to obtain written terms and conditions regarding products designed for such applications. Images are indicative only.

# Flex Left Corner Design features



## 1. Zero Clearance

Self-contained, zero clearance construction allows your Flex fireplace to be framed into wood or metal studs, providing installation freedom and flexibility for builders, architects, interior designers, landscapers and homeowners.

## 2. Decorative Side Box

Customise your fireplace design with a decorative box placed on one or more sides, and fill with your chosen non-combustible accessory.

## Built to Last a Lifetime

Zinc sealed steel construction powder coated with super hi-temp black paint prevents rusting so all fireplaces can be used both indoors or outdoors.

## Quick and Easy Installation

Requiring virtually no assembly, Flex Fireplaces are designed to be placed into the desired location, safely secured into position, and operated immediately.

## 3. Glass Fire Screen/s

The toughened glass fire screen stabilises the flame in windy conditions. The Integrated windscreen sits flush behind the frame.

## No Connections

Light up outdoor spaces with a soft, alluring glow - easily and efficiently, without cumbersome connections.

## 4. Colours

Available in a timeless black finish, Flex Fireplaces come with Stainless Steel or Black burners.

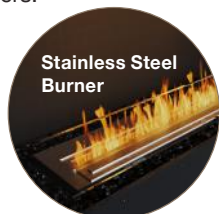

## 5. Single Room Application

Left Corner fireplaces feature two open sides - view the flame from the front and from the left corner.

## No Flue, No Chimney, No Vent

Fuelled by clean-burning e-NRG bioethanol, our burners produce a beautiful orange flame without any smoke, soot or ash.

## Forefront of Fireplace Technology

Backed by 17 years of research and development, and third-party certification, each model in the Flex series features world-class safety and fuel ignition technologies.

## Global Compliance

These models comply with existing standards in the USA, Europe, UK and Australia. O-TL listed to UL1370, EN 16647 BSI Certified and ACCC Safety Mandate compliant.

*\*Decorative media is not to be placed directly on top of the burner or anywhere they can interfere with the operation of the burner or the stability of flame.*

## Included Accessories



Jerry Can with Safety Spout & e-NRG bottle adaptor



Lighting Rod & Lighter



XL Baffles  
(XL Burners Only)



Black Glass Charcoal\*



Glass Fire Screen/s

## Optional Accessories



Decorative Steel Logs\*



Disclaimer. All product specifications and data are subject to change without notice and believed to be correct at the time of publication. MAD Design Group (MDG), its affiliates, agents, and employees, and all persons acting on its or their behalf (collectively, "MAD Design Group"), disclaim any and all liability for any errors, inaccuracies or incompleteness contained herein or in any other disclosure relating to any product. MDG disclaims any and all liability arising out of the use or application of any product described herein or of any information provided herein to the maximum extent permitted by law. The product specifications do not expand or otherwise modify MDG's terms and conditions of purchase, including but not limited to the warranty expressed therein, which apply to these products. No license, express or implied, by estoppel or otherwise, to any intellectual property rights is granted by this document or by any conduct of MDG. Customers using or selling MDG products not expressly indicated for use in such applications do so entirely at their own risk and agree to fully indemnify MDG for any damages arising or resulting from such use or sale. Please contact authorised personnel from MDG to obtain written terms and conditions regarding products designed for such applications. Images are indicative only.

# Flex 50LC Specifications

## Burner Ventilation and Efficiency\*

## Construction

Flex Model	Compatible Burner	Fuel Capacity	Heats on Average (Indoors)	Approx. Burn Time	Minimum Room Size	Viewing Area Size	Minimum Wall Length
<b>50LC</b>	XL900	9 L [2.4 Gals]	Over 60 m <sup>2</sup> [645 ft <sup>2</sup> ]	8 - 13 hours	110 m <sup>3</sup> [3,884 ft <sup>3</sup> ]	1,270mm [50in]	1,475mm [58in]
<b>50LC.BXL</b> <b>50LC.BXR</b>	XL500	5 L [1.3 Gals]	Over 40 m <sup>2</sup> [430.6 ft <sup>2</sup> ]	10 - 13 hours	80 m <sup>3</sup> [2,825 ft <sup>3</sup> ]		

Awards	2020 BIMsmith Best Award (USA) 2018 Attendees Choice Award (USA)
Application	Indoor & Outdoor
Surround Colour	 Black
Burner Colours Options	 Stainless Steel  Black
Materials	Mild Steel (Zinc Sealed) Hi-temp Powder-coat, Toughened Glass, Grade 304 Stainless Steel Burner, with optional Black Ceramic Coating
Approx. Weight	<b>50LC</b> 71.6kg [157.5lbs] <b>50LC.BXL &amp; 50LC.BXR</b> 73.1kg [160.8lbs] Weight includes burner/s, black glass charcoal, fire screen.
Fuel Type	e-NRG Bioethanol / <a href="http://e-NRG.com">e-NRG.com</a>



\*These values are indicative only and may vary depending on the model purchased, installation, and the seasonal resource used to manufacture e-NRG. Physical model dimensions should be verified against cut out dimensions BEFORE installation begins to confirm tolerances align. These models comply with existing standards in the USA, Europe, UK and Australia. O-TL listed to UL1370, EN 16647 BSI Certified and ACCC Safety Mandate compliant.

FOR MORE INFORMATION PLEASE REFERENCE THE CLEARANCE & INSTALLATION MANUAL

Disclaimer: All product specifications and data are subject to change without notice and believed to be correct at the time of publication. MAD Design Group (MDG), its affiliates, agents, and employees, and all persons acting on its or their behalf (collectively, "MAD Design Group"), disclaim any and all liability for any errors, inaccuracies or incompleteness contained herein or in any other disclosure relating to any product. MDG disclaims any and all liability arising out of the use or application of any product described herein or of any information provided herein to the maximum extent permitted by law. The product specifications do not expand or otherwise modify MDG's terms and conditions of purchase, including but not limited to the warranty expressed therein, which apply to these products. No license, express or implied, by estoppel or otherwise, to any intellectual property rights is granted by this document or by any conduct of MDG. Customers using or selling MDG products not expressly indicated for use in such applications do so entirely at their own risk and agree to fully indemnify MDG for any damages arising or resulting from such use or sale. Please contact authorised personnel from MDG to obtain written terms and conditions regarding products designed for such applications. Images are indicative only.

# Flex 50LC

Physical model dimensions should be verified against cut out dimensions BEFORE installation begins to confirm tolerances align.

## ESF.FX.50LC (Flame only)

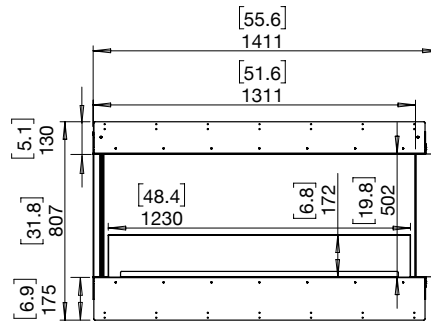

## ESF.FX.50LC.BXL (Left Decorative Box)

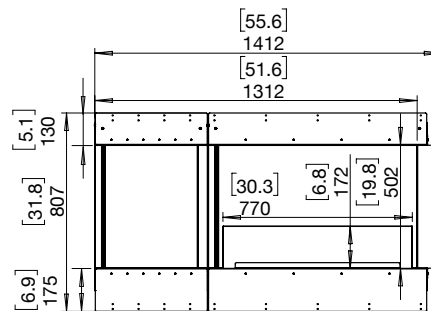

## ESF.FX.50LC.BXR (Right Decorative Box)

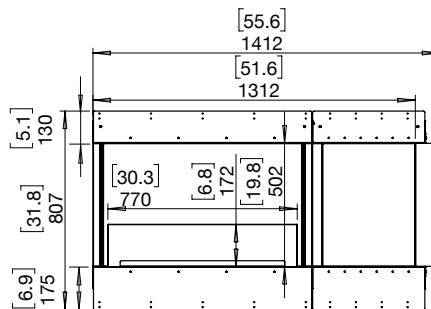

## Side View

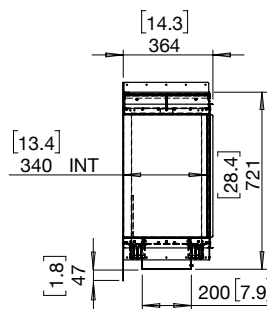

FOR MORE INFORMATION PLEASE REFERENCE THE CLEARANCE & INSTALLATION MANUAL

Disclaimer: All product specifications and data are subject to change without notice and believed to be correct at the time of publication. MAD Design Group (MDG), its affiliates, agents, and employees, and all persons acting on its or their behalf (collectively, "MAD Design Group"), disclaim any and all liability for any errors, inaccuracies or incompleteness contained herein or in any other disclosure relating to any product. MDG disclaims any and all liability arising out of the use or application of any product described herein or of any information provided herein to the maximum extent permitted by law. The product specifications do not expand or otherwise modify MDG's terms and conditions of purchase, including but not limited to the warranty expressed therein, which apply to these products. No license, express or implied, by estoppel or otherwise, to any intellectual property rights is granted by this document or by any conduct of MDG. Customers using or selling MDG products not expressly indicated for use in such applications do so entirely at their own risk and agree to fully indemnify MDG for any damages arising or resulting from such use or sale. Please contact authorized personnel from MDG to obtain written terms and conditions regarding products designed for such applications. Images are indicative only.

# Flex Right Corner Design features

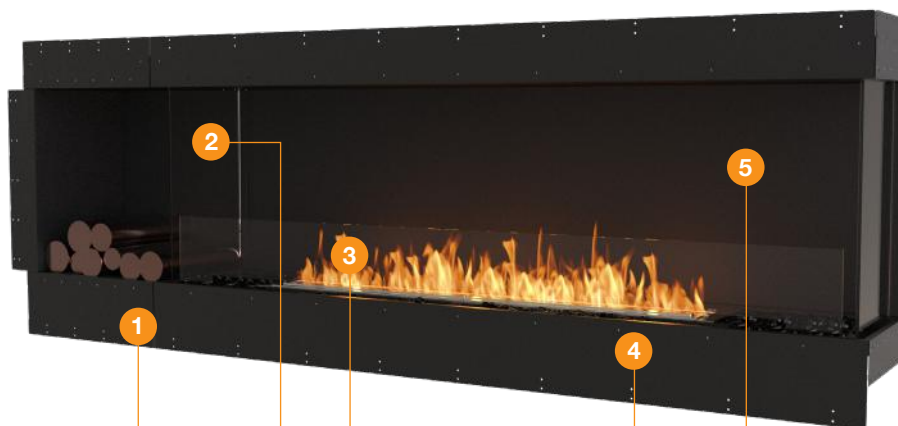

## 1. Zero Clearance

Self-contained, zero clearance construction allows your Flex fireplace to be framed into wood or metal studs, providing installation freedom and flexibility for builders, architects, interior designers, landscapers and homeowners.

## 2. Decorative Side Box

Customise your fireplace design with a decorative box placed on one or more sides, and fill with your chosen non-combustible accessory.

## Built to Last a Lifetime

Zinc sealed steel construction powder coated with super hi-temp black paint prevents rusting so all fireplaces can be used both indoors or outdoors.

## Quick and Easy Installation

Requiring virtually no assembly, Flex Fireplaces are designed to be placed into the desired location, safely secured into position, and operated immediately.

## 3. Glass Fire Screen/s

The toughened glass fire screen stabilises the flame in windy conditions. The Integrated windscreen sits flush behind the frame.

## No Connections

Light up outdoor spaces with a soft, alluring glow - easily and efficiently, without cumbersome connections.

## 4. Colours

Available in a timeless black finish, Flex Fireplaces come with Stainless Steel or Black burners.

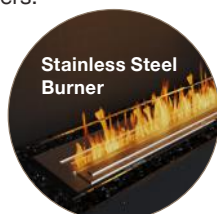

## 5. Single Room Application

Right Corner fireplaces feature two open sides - view the flame from the front and from the right corner.

## No Flue, No Chimney, No Vent

Fuelled by clean-burning e-NRG bioethanol, our burners produce a beautiful orange flame without any smoke, soot or ash.

## Forefront of Fireplace Technology

Backed by 17 years of research and development, and third-party certification, each model in the Flex series features world-class safety and fuel ignition technologies.

## Global Compliance

These models comply with existing standards in the USA, Europe, UK and Australia. O-TL listed to UL1370, EN 16647 BSI Certified and ACCC Safety Mandate compliant.

*\*Decorative media is not to be placed directly on top of the burner or anywhere they can interfere with the operation of the burner or the stability of flame.*

## Included Accessories



Jerry Can with Safety Spout & e-NRG bottle adaptor



Lighting Rod & Lighter



XL Baffles (XL Burners Only)



Black Glass Charcoal\*



Glass Fire Screen/s

## Optional Accessories



Decorative Steel Logs\*



Disclaimer: All product specifications and data are subject to change without notice and believed to be correct at the time of publication. MAD Design Group (MDG), its affiliates, agents, and employees, and all persons acting on its or their behalf (collectively, "MAD Design Group"), disclaim any and all liability for any errors, inaccuracies or incompleteness contained herein or in any other disclosure relating to any product. MDG disclaims any and all liability arising out of the use or application of any product described herein or of any information provided herein to the maximum extent permitted by law. The product specifications do not expand or otherwise modify MDG's terms and conditions of purchase, including but not limited to the warranty expressed therein, which apply to these products. No license, express or implied, by estoppel or otherwise, to any intellectual property rights is granted by this document or by any conduct of MDG. Customers using or selling MDG products not expressly indicated for use in such applications do so entirely at their own risk and agree to fully indemnify MDG for any damages arising or resulting from such use or sale. Please contact authorised personnel from MDG to obtain written terms and conditions regarding products designed for such applications. Images are indicative only.

# Flex 50RC Specifications

## Burner Ventilation and Efficiency\*

## Construction

Flex Model	Compatible Burner	Fuel Capacity	Heats on Average (Indoors)	Approx. Burn Time	Minimum Room Size	Viewing Area Size	Minimum Wall Length
<b>50RC</b>	XL900	9 L [2.4 Gals]	Over 60 m <sup>2</sup> [645 ft <sup>2</sup> ]	8 - 13 hours	110 m <sup>3</sup> [3,884 ft <sup>3</sup> ]	1,270mm [50in]	1,475mm [58in]
<b>50RC.BXL</b> <b>50RC.BXR</b>	XL500	5 L [1.3 Gals]	Over 40 m <sup>2</sup> [430.6 ft <sup>2</sup> ]	10 - 13 hours	80 m <sup>3</sup> [2,825 ft <sup>3</sup> ]		

Awards	2020 BIMsmith Best Award (USA) 2018 Attendees Choice Award (USA)
Application	Indoor & Outdoor
Surround Colour	 Black
Burner Colours Options	 Stainless Steel  Black
Materials	Mild Steel (Zinc Sealed) Hi-temp Powder-coat, Toughened Glass, Grade 304 Stainless Steel Burner, with optional Black Ceramic Coating
Approx. Weight	<b>50RC</b> 71.6kg [157.5lbs] <b>50RC.BXL &amp; 50RC.BXR</b> 73.1kg [160.8lbs] Weight includes burner/s, black glass charcoal, fire screen.
Fuel Type	e-NRG Bioethanol / <a href="http://e-NRG.com">e-NRG.com</a>



\*These values are indicative only and may vary depending on the model purchased, installation, and the seasonal resource used to manufacture e-NRG. Physical model dimensions should be verified against cut out dimensions BEFORE installation begins to confirm tolerances align. These models comply with existing standards in the USA, Europe, UK and Australia. O-TL listed to UL1370, EN 16647 BSI Certified and ACCC Safety Mandate compliant.

FOR MORE INFORMATION PLEASE REFERENCE THE CLEARANCE & INSTALLATION MANUAL

Disclaimer: All product specifications and data are subject to change without notice and believed to be correct at the time of publication. MAD Design Group (MDG), its affiliates, agents, and employees, and all persons acting on its or their behalf (collectively, "MAD Design Group"), disclaim any and all liability for any errors, inaccuracies or incompleteness contained herein or in any other disclosure relating to any product. MDG disclaims any and all liability arising out of the use or application of any product described herein or of any information provided herein to the maximum extent permitted by law. The product specifications do not expand or otherwise modify MDG's terms and conditions of purchase, including but not limited to the warranty expressed therein, which apply to these products. No license, express or implied, by estoppel or otherwise, to any intellectual property rights is granted by this document or by any conduct of MDG. Customers using or selling MDG products not expressly indicated for use in such applications do so entirely at their own risk and agree to fully indemnify MDG for any damages arising or resulting from such use or sale. Please contact authorised personnel from MDG to obtain written terms and conditions regarding products designed for such applications. Images are indicative only.

# Flex 50RC

Physical model dimensions should be verified against cut out dimensions BEFORE installation begins to confirm tolerances align.

## ESF.FX.50RC (Flame only)

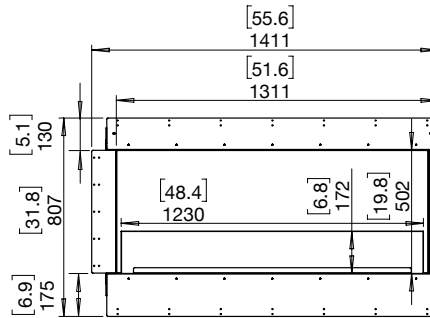

## ESF.FX.50RC.BXL (Left Decorative Box)

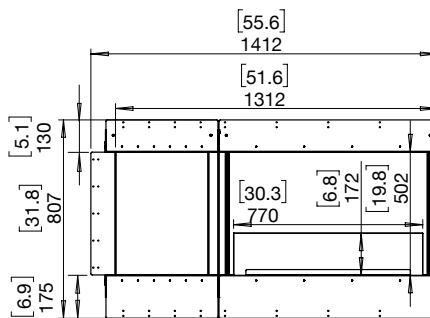

## ESF.FX.50RC.BXR (Right Decorative Box)

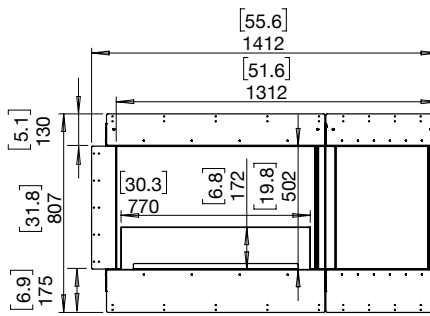

## Side View

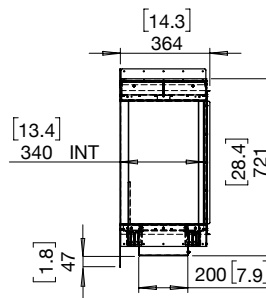

**FOR MORE INFORMATION PLEASE REFERENCE THE CLEARANCE & INSTALLATION MANUAL**

Disclaimer: All product specifications and data are subject to change without notice and believed to be correct at the time of publication. MAD Design Group (MDG), its affiliates, agents, and employees, and all persons acting on its or their behalf (collectively, "MAD Design Group"), disclaim any and all liability for any errors, inaccuracies or incompleteness contained herein or in any other disclosure relating to any product. MDG disclaims any and all liability arising out of the use or application of any product described herein or of any information provided herein to the maximum extent permitted by law. The product specifications do not expand or otherwise modify MDG's terms and conditions of purchase, including but not limited to the warranty expressed therein, which apply to these products. No license, express or implied, by estoppel or otherwise, to any intellectual property rights is granted by this document or by any conduct of MDG. Customers using or selling MDG products not expressly indicated for use in such applications do so entirely at their own risk and agree to fully indemnify MDG for any damages arising or resulting from such use or sale. Please contact authorized personnel from MDG to obtain written terms and conditions regarding products designed for such applications. Images are indicative only.

# Flex Bay Design features



## 1. Zero Clearance

Self-contained, zero clearance construction allows your Flex fireplace to be framed into wood or metal studs, providing installation freedom and flexibility for builders, architects, interior designers, landscapers and homeowners.

## 2. Decorative Side Box

Customise your fireplace design with a decorative box placed on one or more sides, and fill with your chosen non-combustible accessory.

## Built to Last a Lifetime

Zinc sealed steel construction powder coated with super hi-temp black paint prevents rusting so all fireplaces can be used both indoors or outdoors.

## Quick and Easy Installation

Requiring virtually no assembly, Flex Fireplaces are designed to be placed into the desired location, safely secured into position, and operated immediately.

## 3. Glass Fire Screen/s

The toughened glass fire screen stabilises the flame in windy conditions. The Integrated windscreen sits flush behind the frame.

## No Connections

Light up outdoor spaces with a soft, alluring glow - easily and efficiently, without cumbersome connections.

## 4. Colours

Available in a timeless black finish, Flex Fireplaces come with Stainless Steel or Black burners.

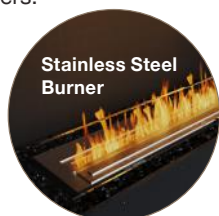

## 5. Single Room Application

Bay fireplaces feature three open sides - view the flame from the front and both sides.

## No Flue, No Chimney, No Vent

Fuelled by clean-burning e-NRG bioethanol, our burners produce a beautiful orange flame without any smoke, soot or ash.

## Forefront of Fireplace Technology

Backed by 17 years of research and development, and third-party certification, each model in the Flex series features world-class safety and fuel ignition technologies.

## Global Compliance

These models comply with existing standards in the USA, Europe, UK and Australia. O-TL listed to UL1370, EN 16647 BSI Certified and ACCC Safety Mandate compliant.

*\*Decorative media is not to be placed directly on top of the burner or anywhere they can interfere with the operation of the burner or the stability of flame.*

## Included Accessories



Jerry Can with Safety Spout & e-NRG bottle adaptor



Lighting Rod & Lighter



XL Baffles (XL Burners Only)



Black Glass Charcoal\*



Glass Fire Screen/s

## Optional Accessories



Decorative Steel Logs\*



Disclaimer: All product specifications and data are subject to change without notice and believed to be correct at the time of publication. MAD Design Group (MDG), its affiliates, agents, and employees, and all persons acting on its or their behalf (collectively, "MAD Design Group"), disclaim any and all liability for any errors, inaccuracies or incompleteness contained herein or in any other disclosure relating to any product. MDG disclaims any and all liability arising out of the use or application of any product described herein or of any information provided herein to the maximum extent permitted by law. The product specifications do not expand or otherwise modify MDG's terms and conditions of purchase, including but not limited to the warranty expressed therein, which apply to these products. No license, express or implied, by estoppel or otherwise, to any intellectual property rights is granted by this document or by any conduct of MDG. Customers using or selling MDG products not expressly indicated for use in such applications do so entirely at their own risk and agree to fully indemnify MDG for any damages arising or resulting from such use or sale. Please contact authorised personnel from MDG to obtain written terms and conditions regarding products designed for such applications. Images are indicative only.

# Flex 50BY Specifications

## Burner Ventilation and Efficiency\*

## Construction

Flex Model	Compatible Burner	Fuel Capacity	Heats on Average (Indoors)	Approx. Burn Time	Minimum Room Size	Viewing Area Size	Minimum Wall Length
<b>50BY</b>	XL900	9 L [2.4 Gals]	Over 60 m <sup>2</sup> [645 ft <sup>2</sup> ]	8 - 13 hours	110 m <sup>3</sup> [3,884 ft <sup>3</sup> ]	1,270mm [50in]	1,475mm [58in]
<b>50BY.BXL</b> <b>50BY.BXR</b>	XL500	5 L [1.3 Gals]	Over 40 m <sup>2</sup> [430.6 ft <sup>2</sup> ]	10 - 13 hours	80 m <sup>3</sup> [2,825 ft <sup>3</sup> ]		

Awards	2020 BIMsmith Best Award (USA) 2018 Attendees Choice Award (USA)
Application	Indoor & Outdoor
Surround Colour	 Black
Burner Colours Options	 Stainless Steel  Black
Materials	Mild Steel (Zinc Sealed) Hi-temp Powder-coat, Toughened Glass, Grade 304 Stainless Steel Burner, with optional Black Ceramic Coating
Approx. Weight	<b>50BY</b> 71.8kg [158lbs] <b>50BY.BXL &amp; 50BY.BXR</b> 76.2kg [167.6lbs] Weight includes burner/s, black glass charcoal, fire screen.
Fuel Type	e-NRG Bioethanol / <a href="http://e-NRG.com">e-NRG.com</a>

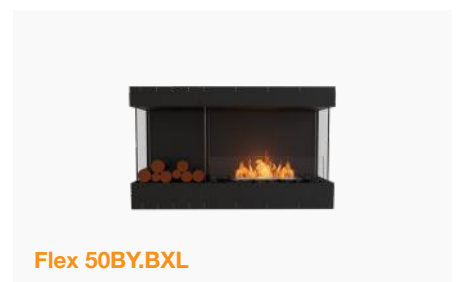

\*These values are indicative only and may vary depending on the model purchased, installation, and the seasonal resource used to manufacture e-NRG. Physical model dimensions should be verified against cut out dimensions BEFORE installation begins to confirm tolerances align. These models comply with existing standards in the USA, Europe, UK and Australia. O-TL listed to UL1370, EN 16647 BSI Certified and ACCC Safety Mandate compliant.

FOR MORE INFORMATION PLEASE REFERENCE THE CLEARANCE & INSTALLATION MANUAL

Disclaimer: All product specifications and data are subject to change without notice and believed to be correct at the time of publication. MAD Design Group (MDG), its affiliates, agents, and employees, and all persons acting on its or their behalf (collectively, "MAD Design Group"), disclaim any and all liability for any errors, inaccuracies or incompleteness contained herein or in any other disclosure relating to any product. MDG disclaims any and all liability arising out of the use or application of any product described herein or of any information provided herein to the maximum extent permitted by law. The product specifications do not expand or otherwise modify MDG's terms and conditions of purchase, including but not limited to the warranty expressed therein, which apply to these products. No license, express or implied, by estoppel or otherwise, to any intellectual property rights is granted by this document or by any conduct of MDG. Customers using or selling MDG products not expressly indicated for use in such applications do so entirely at their own risk and agree to fully indemnify MDG for any damages arising or resulting from such use or sale. Please contact authorised personnel from MDG to obtain written terms and conditions regarding products designed for such applications. Images are indicative only.

# Flex 50BY

Physical model dimensions should be verified against cut out dimensions BEFORE installation begins to confirm tolerances align.

## ESF.FX.50BY (Flame only)

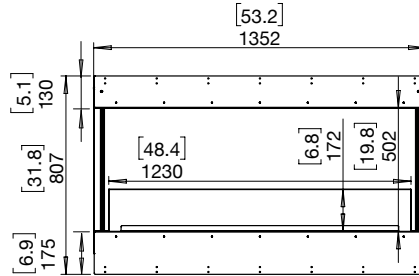

## ESF.FX.50BY.BXL (Left Decorative Box)

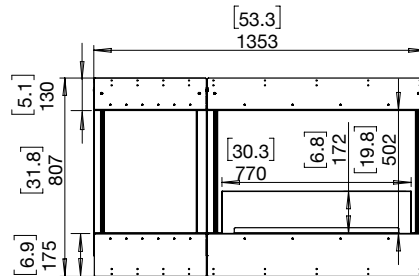

## ESF.FX.50BY.BXR (Right Decorative Box)

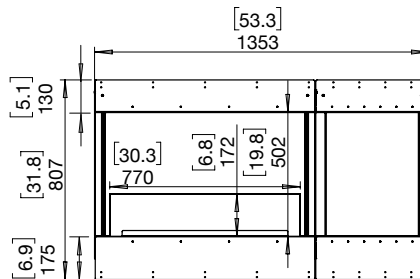

## Side View

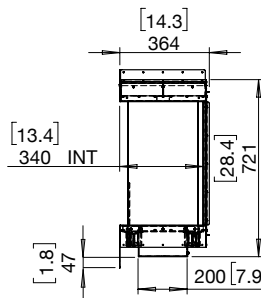

FOR MORE INFORMATION PLEASE REFERENCE THE CLEARANCE & INSTALLATION MANUAL

Disclaimer: All product specifications and data are subject to change without notice and believed to be correct at the time of publication. MAD Design Group (MDG), its affiliates, agents, and employees, and all persons acting on its or their behalf (collectively, "MAD Design Group"), disclaim any and all liability for any errors, inaccuracies or incompleteness contained herein or in any other disclosure relating to any product. MDG disclaims any and all liability arising out of the use or application of any product described herein or of any information provided herein to the maximum extent permitted by law. The product specifications do not expand or otherwise modify MDG's terms and conditions of purchase, including but not limited to the warranty expressed therein, which apply to these products. No license, express or implied, by estoppel or otherwise, to any intellectual property rights is granted by this document or by any conduct of MDG. Customers using or selling MDG products not expressly indicated for use in such applications do so entirely at their own risk and agree to fully indemnify MDG for any damages arising or resulting from such use or sale. Please contact authorized personnel from MDG to obtain written terms and conditions regarding products designed for such applications. Images are indicative only.

# Flex Peninsula Design features

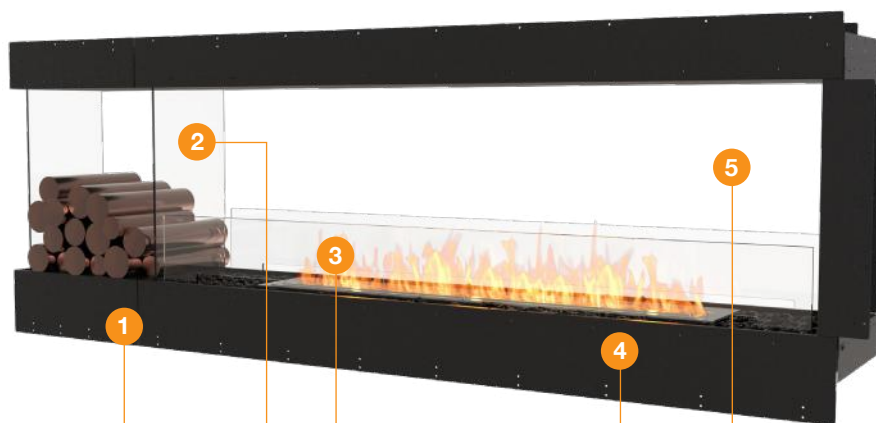

## 1. Zero Clearance

Self-contained, zero clearance construction allows your Flex fireplace to be framed into wood or metal studs, providing installation freedom and flexibility for builders, architects, interior designers, landscapers and homeowners.

## 2. Decorative Side Box

Customise your fireplace design with a decorative box placed on one or more sides, and fill with your chosen non-combustible accessory.

## Built to Last a Lifetime

Zinc sealed steel construction powder coated with super hi-temp black paint prevents rusting so all fireplaces can be used both indoors or outdoors.

## Quick and Easy Installation

Requiring virtually no assembly, Flex Fireplaces are designed to be placed into the desired location, safely secured into position, and operated immediately.

## 3. Glass Fire Screen/s

The toughened glass fire screen stabilises the flame in windy conditions. The Integrated windscreen sits flush behind the frame.

## No Connections

Light up outdoor spaces with a soft, alluring glow - easily and efficiently, without cumbersome connections.

## 4. Colours

Available in a timeless black finish, Flex Fireplaces come with Stainless Steel or Black burners.



## 5. Room Divider Application

Peninsula fireplaces feature three open sides - view the flame from the front, back and open side.

## No Flue, No Chimney, No Vent

Fuelled by clean-burning e-NRG bioethanol, our burners produce a beautiful orange flame without any smoke, soot or ash.

## Forefront of Fireplace Technology

Backed by 17 years of research and development, and third-party certification, each model in the Flex series features world-class safety and fuel ignition technologies.

## Global Compliance

These models comply with existing standards in the USA, Europe, UK and Australia. O-TL listed to UL1370, EN 16647 BSI Certified and ACCC Safety Mandate compliant.

*\*Decorative media is not to be placed directly on top of the burner or anywhere they can interfere with the operation of the burner or the stability of flame.*

## Included Accessories



Jerry Can with Safety Spout & e-NRG bottle adaptor



Lighting Rod & Lighter



XL Baffles  
(XL Burners Only)



Black Glass Charcoal\*



Glass Fire Screen/s

## Optional Accessories



Decorative Steel Logs\*



Disclaimer. All product specifications and data are subject to change without notice and believed to be correct at the time of publication. MAD Design Group (MDG), its affiliates, agents, and employees, and all persons acting on its or their behalf (collectively, "MAD Design Group"), disclaim any and all liability for any errors, inaccuracies or incompleteness contained herein or in any other disclosure relating to any product. MDG disclaims any and all liability arising out of the use or application of any product described herein or of any information provided herein to the maximum extent permitted by law. The product specifications do not expand or otherwise modify MDG's terms and conditions of purchase, including but not limited to the warranty expressed therein, which apply to these products. No license, express or implied, by estoppel or otherwise, to any intellectual property rights is granted by this document or by any conduct of MDG. Customers using or selling MDG products not expressly indicated for use in such applications do so entirely at their own risk and agree to fully indemnify MDG for any damages arising or resulting from such use or sale. Please contact authorised personnel from MDG to obtain written terms and conditions regarding products designed for such applications. Images are indicative only.

# Flex 50PN Specifications

## Burner Ventilation and Efficiency\*

## Construction

Flex Model	Compatible Burner	Fuel Capacity	Heats on Average (Indoors)	Approx. Burn Time	Minimum Room Size	Viewing Area Size	Minimum Wall Length
50PN	XL900	9 L [2.4 Gals]	Over 60 m <sup>2</sup> [645 ft <sup>2</sup> ]	8 - 13 hours	110 m <sup>3</sup> [3,884 ft <sup>3</sup> ]	1,270mm [50in]	1,475mm [58in]
50PN.BXL 50PN.BXR	XL500	5 L [1.3 Gals]	Over 40 m <sup>2</sup> [430.6 ft <sup>2</sup> ]	10 - 13 hours	80 m <sup>3</sup> [2,825 ft <sup>3</sup> ]		

Awards	2020 BIMsmith Best Award (USA) 2018 Attendees Choice Award (USA)
Application	Indoor & Outdoor
Surround Colour	 Black
Burner Colours Options	 Stainless Steel  Black
Materials	Mild Steel (Zinc Sealed) Hi-temp Powder-coat, Toughened Glass, Grade 304 Stainless Steel Burner, with optional Black Ceramic Coating
Approx. Weight	<b>50PN</b> 59.1kg [130lbs] <b>50PN.BXL &amp; 50PN.BXR</b> 73.2kg [161lbs] Weight includes burner/s, black glass charcoal, fire screen.
Fuel Type	e-NRG Bioethanol / <a href="http://e-NRG.com">e-NRG.com</a>

Flip 



Flip 

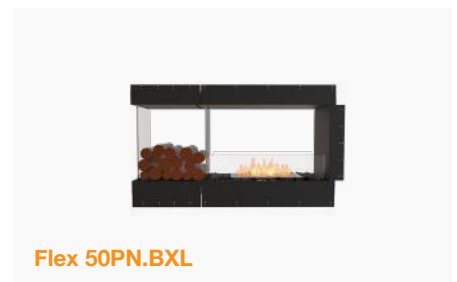

Flip 



\*These values are indicative only and may vary depending on the model purchased, installation, and the seasonal resource used to manufacture e-NRG. Physical model dimensions should be verified against cut out dimensions BEFORE installation begins to confirm tolerances align.

These models comply with existing standards in the USA, Europe, UK and Australia. O-TL listed to UL1370, EN 16647 BSI Certified and ACCC Safety Mandate compliant.

FOR MORE INFORMATION PLEASE REFERENCE THE CLEARANCE & INSTALLATION MANUAL

Disclaimer: All product specifications and data are subject to change without notice and believed to be correct at the time of publication. MAD Design Group (MDG), its affiliates, agents, and employees, and all persons acting on its or their behalf (collectively, "MAD Design Group"), disclaim any and all liability for any errors, inaccuracies or incompleteness contained herein or in any other disclosure relating to any product. MDG disclaims any and all liability arising out of the use or application of any product described herein or of any information provided herein to the maximum extent permitted by law. The product specifications do not expand or otherwise modify MDG's terms and conditions of purchase, including but not limited to the warranty expressed therein, which apply to these products. No license, express or implied, by estoppel or otherwise, to any intellectual property rights is granted by this document or by any conduct of MDG. Customers using or selling MDG products not expressly indicated for use in such applications do so entirely at their own risk and agree to fully indemnify MDG for any damages arising or resulting from such use or sale. Please contact authorised personnel from MDG to obtain written terms and conditions regarding products designed for such applications. Images are indicative only.

# Flex 50PN

Physical model dimensions should be verified against cut out dimensions BEFORE installation begins to confirm tolerances align.

## ESF.FX.50PN (Flame only)

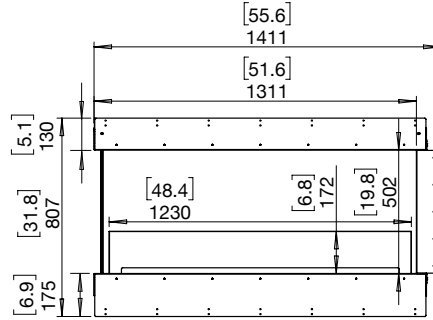

## ESF.FX.50PN.BXL (Left Decorative Box)

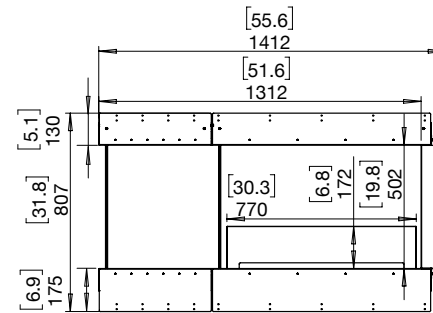

## ESF.FX.50PN.BXR (Right Decorative Box)

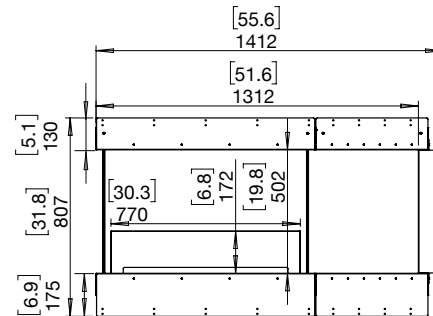

Side View

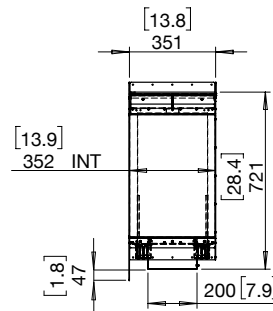
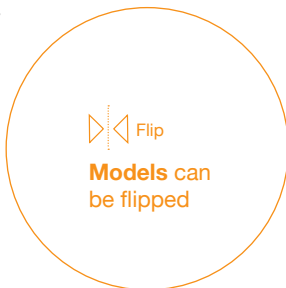

FOR MORE INFORMATION PLEASE REFERENCE THE CLEARANCE & INSTALLATION MANUAL

Disclaimer: All product specifications and data are subject to change without notice and believed to be correct at the time of publication. MAD Design Group (MDG), its affiliates, agents, and employees, and all persons acting on its or their behalf (collectively, "MAD Design Group"), disclaim any and all liability for any errors, inaccuracies or incompleteness contained herein or in any other disclosure relating to any product. MDG disclaims any and all liability arising out of the use or application of any product described herein or of any information provided herein to the maximum extent permitted by law. The product specifications do not expand or otherwise modify MDG's terms and conditions of purchase, including but not limited to the warranty expressed therein, which apply to these products. No license, express or implied, by estoppel or otherwise, to any intellectual property rights is granted by this document or by any conduct of MDG. Customers using or selling MDG products not expressly indicated for use in such applications do so entirely at their own risk and agree to fully indemnify MDG for any damages arising or resulting from such use or sale. Please contact authorized personnel from MDG to obtain written terms and conditions regarding products designed for such applications. Images are indicative only.

# Flex Double Sided Design features

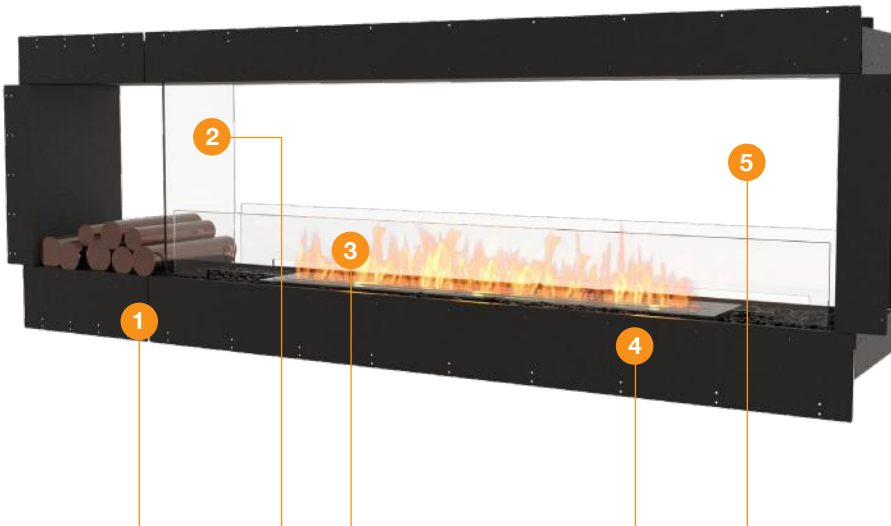

## 1. Zero Clearance

Self-contained, zero clearance construction allows your Flex fireplace to be framed into wood or metal studs, providing installation freedom and flexibility for builders, architects, interior designers, landscapers and homeowners.

## 2. Decorative Side Box

Customise your fireplace design with a decorative box placed on one or more sides, and fill with your chosen non-combustible accessory.

## Built to Last a Lifetime

Zinc sealed steel construction powder coated with super hi-temp black paint prevents rusting so all fireplaces can be used both indoors or outdoors.

## Quick and Easy Installation

Requiring virtually no assembly, Flex Fireplaces are designed to be placed into the desired location, safely secured into position, and operated immediately.

## 3. Glass Fire Screen/s

The toughened glass fire screen stabilises the flame in windy conditions. The Integrated windscreen sits flush behind the frame.

## No Connections

Light up outdoor spaces with a soft, alluring glow - easily and efficiently, without cumbersome connections.

## 4. Colours

Available in a timeless black finish, Flex Fireplaces come with Stainless Steel or Black burners.



## 5. Room Divider Application

Double sided Fireplaces feature two open sides - view the flame from the front and the back.

## No Flue, No Chimney, No Vent

Fueled by clean-burning e-NRG bioethanol, our burners produce a beautiful orange flame without any smoke, soot or ash.

## Forefront of Fireplace Technology

Backed by 17 years of research and development, and third-party certification, each model in the Flex series features world-class safety and fuel ignition technologies.

## Global Compliance

These models comply with existing standards in the USA, Europe, UK and Australia. O-TL listed to UL1370, EN 16647 BSI Certified and ACCC Safety Mandate compliant.

*\*Decorative media is not to be placed directly on top of the burner or anywhere they can interfere with the operation of the burner or the stability of flame.*

## Included Accessories



Jerry Can with Safety Spout & e-NRG bottle adaptor



Lighting Rod & Lighter



XL Baffles (XL Burners Only)



Black Glass Charcoal\*



Glass Fire Screen/s

## Optional Accessories



Decorative Steel Logs\*



Disclaimer: All product specifications and data are subject to change without notice and believed to be correct at the time of publication. MAD Design Group (MDG), its affiliates, agents, and employees, and all persons acting on its or their behalf (collectively, "MAD Design Group"), disclaim any and all liability for any errors, inaccuracies or incompleteness contained herein or in any other disclosure relating to any product. MDG disclaims any and all liability arising out of the use or application of any product described herein or of any information provided herein to the maximum extent permitted by law. The product specifications do not expand or otherwise modify MDG's terms and conditions of purchase, including but not limited to the warranty expressed therein, which apply to these products. No license, express or implied, by estoppel or otherwise, to any intellectual property rights is granted by this document or by any conduct of MDG. Customers using or selling MDG products not expressly indicated for use in such applications do so entirely at their own risk and agree to fully indemnify MDG for any damages arising or resulting from such use or sale. Please contact authorised personnel from MDG to obtain written terms and conditions regarding products designed for such applications. Images are indicative only.

# Flex 50DB Specifications

## Burner Ventilation and Efficiency\*

## Construction

Flex Model	Compatible Burner	Fuel Capacity	Heats on Average (Indoors)	Approx. Burn Time	Minimum Room Size	Viewing Area Size	Minimum Wall Length
<b>50DB</b>	XL900	9 L [2.4 Gals]	Over 60 m <sup>2</sup> [645 ft <sup>2</sup> ]	8 - 13 hours	110 m <sup>3</sup> [3,884 ft <sup>3</sup> ]	1,270mm [50in]	1,475mm [58in]
<b>50DB.BX1</b>	XL500	5 L [1.3 Gals]	Over 40 m <sup>2</sup> [430.6 ft <sup>2</sup> ]	10 - 13 hours	80 m <sup>3</sup> [2,825 ft <sup>3</sup> ]		

Awards	2020 BIMsmith Best Award (USA) 2018 Attendees Choice Award (USA)
Application	Indoor & Outdoor
Surround Colour	 Black
Burner Colours Options	 Stainless Steel  Black
Materials	Mild Steel (Zinc Sealed) Hi-temp Powder-coat, Toughened Glass, Grade 304 Stainless Steel Burner, with optional Black Ceramic Coating
Approx. Weight	<b>50DB</b> 70.8kg [155.8lbs] <b>50DB.BX1</b> 70kg [154lbs] Weight includes burner/s, black glass charcoal, fire screen.
Fuel Type	e-NRG Bioethanol / <a href="http://e-NRG.com">e-NRG.com</a>

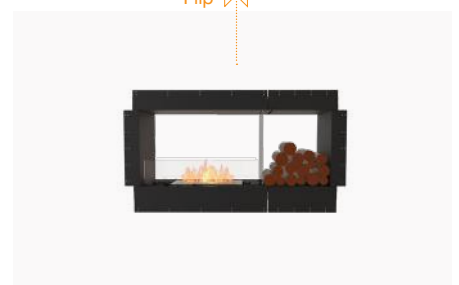

\*These values are indicative only and may vary depending on the model purchased, installation, and the seasonal resource used to manufacture e-NRG. Physical model dimensions should be verified against cut out dimensions BEFORE installation begins to confirm tolerances align. These models comply with existing standards in the USA, Europe, UK and Australia. O-TL listed to UL1370, EN 16647 BSI Certified and ACCC Safety Mandate compliant.

FOR MORE INFORMATION PLEASE REFERENCE THE CLEARANCE & INSTALLATION MANUAL

Disclaimer: All product specifications and data are subject to change without notice and believed to be correct at the time of publication. MAD Design Group (MDG), its affiliates, agents, and employees, and all persons acting on its or their behalf (collectively, "MAD Design Group"), disclaim any and all liability for any errors, inaccuracies or incompleteness contained herein or in any other disclosure relating to any product. MDG disclaims any and all liability arising out of the use or application of any product described herein or of any information provided herein to the maximum extent permitted by law. The product specifications do not expand or otherwise modify MDG's terms and conditions of purchase, including but not limited to the warranty expressed therein, which apply to these products. No license, express or implied, by estoppel or otherwise, to any intellectual property rights is granted by this document or by any conduct of MDG. Customers using or selling MDG products not expressly indicated for use in such applications do so entirely at their own risk and agree to fully indemnify MDG for any damages arising or resulting from such use or sale. Please contact authorised personnel from MDG to obtain written terms and conditions regarding products designed for such applications. Images are indicative only.

# Flex 50DB

Physical model dimensions should be verified against cut out dimensions BEFORE installation begins to confirm tolerances align.

## ESF.FX.50DB (Flame only)

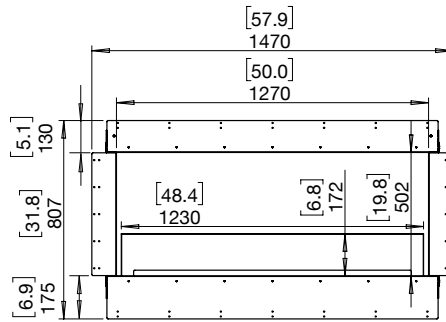

## ESF.FX.50DB.BX1 (Left Decorative Box)

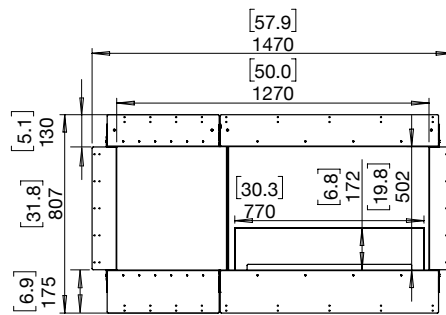

**50DB.BX1** can be flipped so decorative box sits on the right.

## Side View

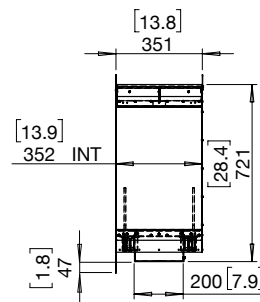

FOR MORE INFORMATION PLEASE REFERENCE THE CLEARANCE & INSTALLATION MANUAL

Disclaimer: All product specifications and data are subject to change without notice and believed to be correct at the time of publication. MAD Design Group (MDG), its affiliates, agents, and employees, and all persons acting on its or their behalf (collectively, "MAD Design Group"), disclaim any and all liability for any errors, inaccuracies or incompleteness contained herein or in any other disclosure relating to any product. MDG disclaims any and all liability arising out of the use or application of any product described herein or of any information provided herein to the maximum extent permitted by law. The product specifications do not expand or otherwise modify MDG's terms and conditions of purchase, including but not limited to the warranty expressed therein, which apply to these products. No license, express or implied, by estoppel or otherwise, to any intellectual property rights is granted by this document or by any conduct of MDG. Customers using or selling MDG products not expressly indicated for use in such applications do so entirely at their own risk and agree to fully indemnify MDG for any damages arising or resulting from such use or sale. Please contact authorized personnel from MDG to obtain written terms and conditions regarding products designed for such applications. Images are indicative only.

# Flex Island Design features

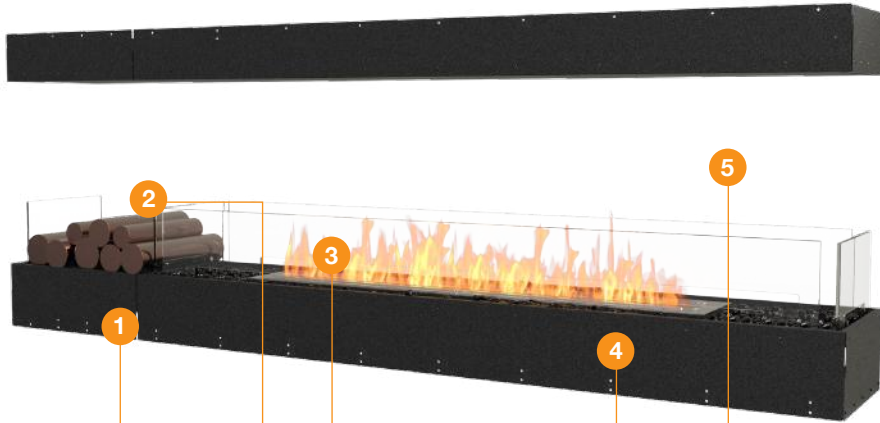

## 1. Zero Clearance

Self-contained, zero clearance construction allows your Flex fireplace to be framed into wood or metal studs, providing installation freedom and flexibility for builders, architects, interior designers, landscapers and homeowners.

## 2. Decorative Side Box

Customise your fireplace design with a decorative box placed on one or more sides, and fill with your chosen non-combustible accessory.

## Built to Last a Lifetime

Zinc sealed steel construction powder coated with super hi-temp black paint prevents rusting so all fireplaces can be used both indoors or outdoors.

## Quick and Easy Installation

Requiring virtually no assembly, Flex Fireplaces are designed to be placed into the desired location, safely secured into position, and operated immediately.

## 3. Glass Fire Screen/s

The toughened glass fire screen stabilises the flame in windy conditions. The Integrated windscreen sits flush behind the frame.

## No Connections

Light up outdoor spaces with a soft, alluring glow - easily and efficiently, without cumbersome connections.

## 4. Colours

Available in a timeless black finish, Flex Fireplaces come with Stainless Steel or Black burners.



## 5. Room Divider Application

Four-sided fireplaces feature four open sides - view the flame from the front, back and sides.

## No Flue, No Chimney, No Vent

Fuelled by clean-burning e-NRG bioethanol, our burners produce a beautiful orange flame without any smoke, soot or ash.

## Forefront of Fireplace Technology

Backed by 17 years of research and development, and third-party certification, each model in the Flex series features world-class safety and fuel ignition technologies.

## Global Compliance

These models comply with existing standards in the USA, Europe, UK and Australia. O-TL listed to UL1370, EN 16647 BSI Certified and ACCC Safety Mandate compliant.

*\*Decorative media is not to be placed directly on top of the burner or anywhere they can interfere with the operation of the burner or the stability of flame.*

## Included Accessories



Jerry Can with Safety Spout & e-NRG bottle adaptor



Lighting Rod & Lighter



XL Baffles  
(XL Burners Only)



Black Glass Charcoal\*



Glass Fire Screen/s

## Optional Accessories



Decorative Steel Logs\*

Disclaimer. All product specifications and data are subject to change without notice and believed to be correct at the time of publication. MAD Design Group (MDG), its affiliates, agents, and employees, and all persons acting on its or their behalf (collectively, "MAD Design Group"), disclaim any and all liability for any errors, inaccuracies or incompleteness contained herein or in any other disclosure relating to any product. MDG disclaims any and all liability arising out of the use or application of any product described herein or of any information provided herein to the maximum extent permitted by law. The product specifications do not expand or otherwise modify MDG's terms and conditions of purchase, including but not limited to the warranty expressed therein, which apply to these products. No license, express or implied, by estoppel or otherwise, to any intellectual property rights is granted by this document or by any conduct of MDG. Customers using or selling MDG products not expressly indicated for use in such applications do so entirely at their own risk and agree to fully indemnify MDG for any damages arising or resulting from such use or sale. Please contact authorised personnel from MDG to obtain written terms and conditions regarding products designed for such applications. Images are indicative only.

# Flex 50iL Specifications

## Burner Ventilation and Efficiency\*

## Construction

Flex Model	Compatible Burner	Fuel Capacity	Heats on Average (Indoors)	Approx. Burn Time	Minimum Room Size	Viewing Area Size	Minimum Wall Length
<b>50iL</b>	XL900	9 L [2.4 Gals]	Over 60 m <sup>2</sup> [645 ft <sup>2</sup> ]	8 - 13 hours	110 m <sup>3</sup> [3,884 ft <sup>3</sup> ]	1,270mm [50in]	1,475mm [58in]
<b>50iL.BX1</b>	XL500	5 L [1.3 Gals]	Over 40 m <sup>2</sup> [430.6 ft <sup>2</sup> ]	10 - 13 hours	80 m <sup>3</sup> [2,825 ft <sup>3</sup> ]		

Awards	2020 BIMsmith Best Award (USA) 2018 Attendees Choice Award (USA)
Application	Indoor & Outdoor
Surround Colour	Black
Burner Colours Options	Stainless Steel  Black
Materials	Mild Steel (Zinc Sealed) Hi-temp Powder-coat, Toughened Glass, Grade 304 Stainless Steel Burner, with optional Black Ceramic Coating
Approx. Weight	<b>50iL</b> 59.9kg [131.8lbs] <b>50iL.BX1</b> 48.3kg [106.3lbs] Weight includes burner/s, black glass charcoal, fire screen.
Fuel Type	e-NRG Bioethanol / <a href="http://e-NRG.com">e-NRG.com</a>

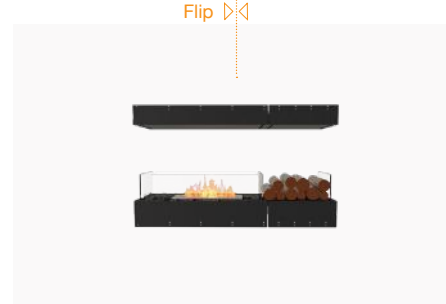

\*These values are indicative only and may vary depending on the model purchased, installation, and the seasonal resource used to manufacture e-NRG. Physical model dimensions should be verified against cut out dimensions BEFORE installation begins to confirm tolerances align. These models comply with existing standards in the USA, Europe, UK and Australia. O-TL listed to UL1370, EN 16647 BSI Certified and ACCC Safety Mandate compliant.

FOR MORE INFORMATION PLEASE REFERENCE THE CLEARANCE & INSTALLATION MANUAL

Disclaimer: All product specifications and data are subject to change without notice and believed to be correct at the time of publication. MAD Design Group (MDG), its affiliates, agents, and employees, and all persons acting on its or their behalf (collectively, "MAD Design Group"), disclaim any and all liability for any errors, inaccuracies or incompleteness contained herein or in any other disclosure relating to any product. MDG disclaims any and all liability arising out of the use or application of any product described herein or of any information provided herein to the maximum extent permitted by law. The product specifications do not expand or otherwise modify MDG's terms and conditions of purchase, including but not limited to the warranty expressed therein, which apply to these products. No license, express or implied, by estoppel or otherwise, to any intellectual property rights is granted by this document or by any conduct of MDG. Customers using or selling MDG products not expressly indicated for use in such applications do so entirely at their own risk and agree to fully indemnify MDG for any damages arising or resulting from such use or sale. Please contact authorised personnel from MDG to obtain written terms and conditions regarding products designed for such applications. Images are indicative only.

# Flex 50IL

Physical model dimensions should be verified against cut out dimensions BEFORE installation begins to confirm tolerances align.

## ESF.FX.50IL (Flame only)

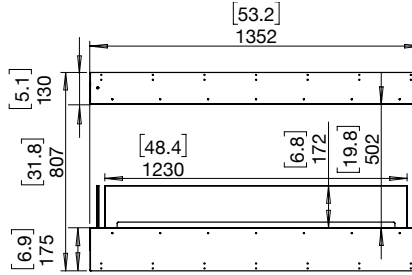

## ESF.FX.50IL.BX1 (Left Decorative Box)

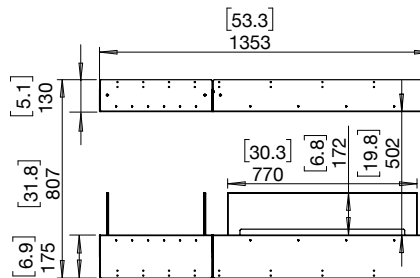

Flip

**50IL.BX1** can be flipped so decorative box sits on the right.

Side View

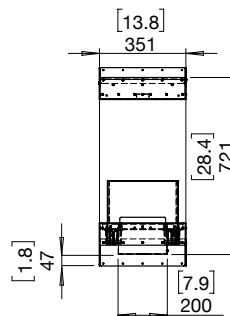

**FOR MORE INFORMATION PLEASE REFERENCE THE CLEARANCE & INSTALLATION MANUAL**

Disclaimer: All product specifications and data are subject to change without notice and believed to be correct at the time of publication. MAD Design Group (MDG), its affiliates, agents, and employees, and all persons acting on its or their behalf (collectively, "MAD Design Group"), disclaim any and all liability for any errors, inaccuracies or incompleteness contained herein or in any other disclosure relating to any product. MDG disclaims any and all liability arising out of the use or application of any product described herein or of any information provided herein to the maximum extent permitted by law. The product specifications do not expand or otherwise modify MDG's terms and conditions of purchase, including but not limited to the warranty expressed therein, which apply to these products. No license, express or implied, by estoppel or otherwise, to any intellectual property rights is granted by this document or by any conduct of MDG. Customers using or selling MDG products not expressly indicated for use in such applications do so entirely at their own risk and agree to fully indemnify MDG for any damages arising or resulting from such use or sale. Please contact authorized personnel from MDG to obtain written terms and conditions regarding products designed for such applications. Images are indicative only.

# Flex Bench Design features

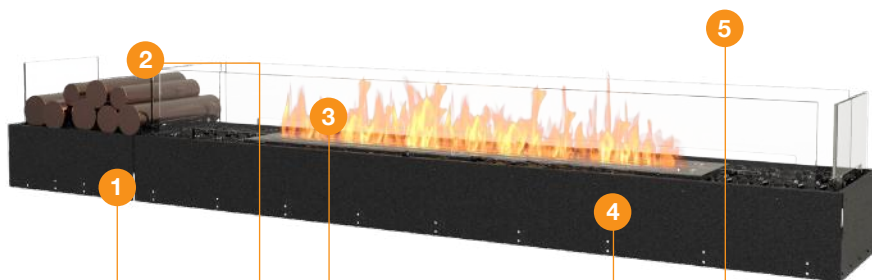

## 1. Zero Clearance

Self-contained, zero clearance construction allows your Flex fireplace to be framed into wood or metal studs, providing installation freedom and flexibility for builders, architects, interior designers, landscapers and homeowners.

## 2. Decorative Side Box

Customise your fireplace design with a decorative box placed on one or more sides, and fill with your chosen non-combustible accessory.

## Built to Last a Lifetime

Zinc sealed steel construction powder coated with super hi-temp black paint prevents rusting so all fireplaces can be used both indoors or outdoors.

## Quick and Easy Installation

Requiring virtually no assembly, Flex Fireplaces are designed to be placed into the desired location, safely secured into position, and operated immediately.

## 3. Glass Fire Screen/s

The toughened glass fire screen stabilises the flame in windy conditions. The Integrated windscreen sits flush behind the frame.

## No Connections

Light up outdoor spaces with a soft, alluring glow - easily and efficiently, without cumbersome connections.

## 4. Colours

Available in a timeless black finish, Flex Fireplaces come with Stainless Steel or Black burners.

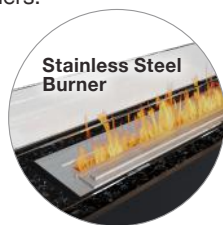

## 5. Room Divider Application

Four-sided fireplaces feature four open sides - view the flame from the front, back and sides.

## No Flue, No Chimney, No Vent

Fuelled by clean-burning e-NRG bioethanol, our burners produce a beautiful orange flame without any smoke, soot or ash.

## Forefront of Fireplace Technology

Backed by 17 years of research and development, and third-party certification, each model in the Flex series features world-class safety and fuel ignition technologies.

## Global Compliance

These models comply with existing standards in the USA, Europe, UK and Australia. O-TL listed to UL1370, EN 16647 BSI Certified and ACCC Safety Mandate compliant.

*\*Decorative media is not to be placed directly on top of the burner or anywhere they can interfere with the operation of the burner or the stability of flame.*

## Included Accessories



Jerry Can with Safety Spout & e-NRG bottle adaptor



Lighting Rod & Lighter



XL Baffles  
(XL Burners Only)



Black Glass Charcoal\*



Glass Fire Screen/s

## Optional Accessories



Decorative Steel Logs\*



Disclaimer. All product specifications and data are subject to change without notice and believed to be correct at the time of publication. MAD Design Group (MDG), its affiliates, agents, and employees, and all persons acting on its or their behalf (collectively, "MAD Design Group"), disclaim any and all liability for any errors, inaccuracies or incompleteness contained herein or in any other disclosure relating to any product. MDG disclaims any and all liability arising out of the use or application of any product described herein or of any information provided herein to the maximum extent permitted by law. The product specifications do not expand or otherwise modify MDG's terms and conditions of purchase, including but not limited to the warranty expressed therein, which apply to these products. No license, express or implied, by estoppel or otherwise, to any intellectual property rights is granted by this document or by any conduct of MDG. Customers using or selling MDG products not expressly indicated for use in such applications do so entirely at their own risk and agree to fully indemnify MDG for any damages arising or resulting from such use or sale. Please contact authorised personnel from MDG to obtain written terms and conditions regarding products designed for such applications. Images are indicative only.

# Flex 50BN Specifications

## Burner Ventilation and Efficiency\*

## Construction

Flex Model	Compatible Burner	Fuel Capacity	Heats on Average (Indoors)	Approx. Burn Time	Minimum Room Size	Viewing Area Size	Minimum Wall Length
50BN	XL900	9 L [2.4 Gals]	Over 60 m <sup>2</sup> [645 ft <sup>2</sup> ]	8 - 13 hours	110 m <sup>3</sup> [3,884 ft <sup>3</sup> ]	1,270mm [50in]	1,475mm [58in]
50BN.BX1	XL500	5 L [1.3 Gals]	Over 40 m <sup>2</sup> [430.6 ft <sup>2</sup> ]	10 - 13 hours	80 m <sup>3</sup> [2,825 ft <sup>3</sup> ]		

Awards	2020 BIMsmith Best Award (USA) 2018 Attendees Choice Award (USA)
Application	Indoor & Outdoor
Surround Colour	 Black
Burner Colours Options	 Stainless Steel  Black
Materials	Mild Steel (Zinc Sealed) Hi-temp Powder-coat, Toughened Glass, Grade 304 Stainless Steel Burner, with optional Black Ceramic Coating
Approx. Weight	<b>50BN</b> 39.5kg [86.9lbs] <b>50BN.BX1</b> 38.4kg [84.5lbs] Weight includes burner/s, black glass charcoal, fire screen.
Fuel Type	e-NRG Bioethanol / <a href="http://e-NRG.com">e-NRG.com</a>

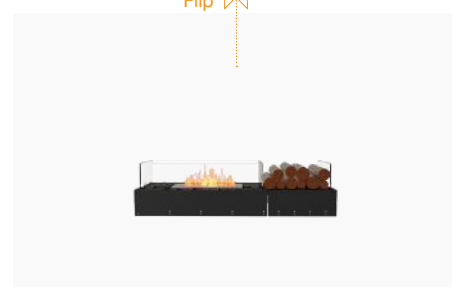

\*These values are indicative only and may vary depending on the model purchased, installation, and the seasonal resource used to manufacture e-NRG. Physical model dimensions should be verified against cut out dimensions BEFORE installation begins to confirm tolerances align. These models comply with existing standards in the USA, Europe, UK and Australia. O-TL listed to UL1370, EN 16647 BSI Certified and ACCC Safety Mandate compliant.

FOR MORE INFORMATION PLEASE REFERENCE THE CLEARANCE & INSTALLATION MANUAL

Disclaimer: All product specifications and data are subject to change without notice and believed to be correct at the time of publication. MAD Design Group (MDG), its affiliates, agents, and employees, and all persons acting on its or their behalf (collectively, "MAD Design Group"), disclaim any and all liability for any errors, inaccuracies or incompleteness contained herein or in any other disclosure relating to any product. MDG disclaims any and all liability arising out of the use or application of any product described herein or of any information provided herein to the maximum extent permitted by law. The product specifications do not expand or otherwise modify MDG's terms and conditions of purchase, including but not limited to the warranty expressed therein, which apply to these products. No license, express or implied, by estoppel or otherwise, to any intellectual property rights is granted by this document or by any conduct of MDG. Customers using or selling MDG products not expressly indicated for use in such applications do so entirely at their own risk and agree to fully indemnify MDG for any damages arising or resulting from such use or sale. Please contact authorised personnel from MDG to obtain written terms and conditions regarding products designed for such applications. Images are indicative only.

# Flex 50BN

Physical model dimensions should be verified against cut out dimensions BEFORE installation begins to confirm tolerances align.

## ESF.FX.50BN (Flame only)

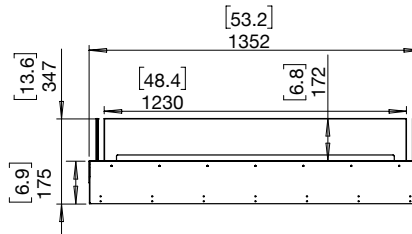

## ESF.FX.50BN.BX1 (Left Decorative Box)

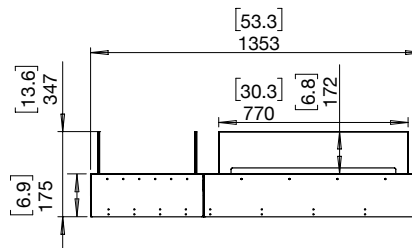

## Side View

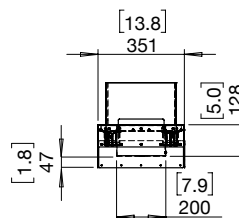

FOR MORE INFORMATION PLEASE REFERENCE THE CLEARANCE & INSTALLATION MANUAL

Disclaimer: All product specifications and data are subject to change without notice and believed to be correct at the time of publication. MAD Design Group (MDG), its affiliates, agents, and employees, and all persons acting on its or their behalf (collectively, "MAD Design Group"), disclaim any and all liability for any errors, inaccuracies or incompleteness contained herein or in any other disclosure relating to any product. MDG disclaims any and all liability arising out of the use or application of any product described herein or of any information provided herein to the maximum extent permitted by law. The product specifications do not expand or otherwise modify MDG's terms and conditions of purchase, including but not limited to the warranty expressed therein, which apply to these products. No license, express or implied, by estoppel or otherwise, to any intellectual property rights is granted by this document or by any conduct of MDG. Customers using or selling MDG products not expressly indicated for use in such applications do so entirely at their own risk and agree to fully indemnify MDG for any damages arising or resulting from such use or sale. Please contact authorized personnel from MDG to obtain written terms and conditions regarding products designed for such applications. Images are indicative only.